

BLUE GIANT[®]

VERTICAL STORING DOCK LEVELER

LOAD USAGE

Up to 33,000 lb
(15,000 kg)

LOAD CLASS

Heavy
Super
Extreme

NEXT
GEN



Control Your Environment
Energy Savings. Safety. Cleanliness.

PERFORMANCE & EFFICIENCY

- **EasyClean™** provides a streamlined frame layout with minimal obstructions, allowing for easier cleaning and maintenance.
- Double acting hydraulic cylinders with full power control for deck and lip operations.
- NEMA4X control station for wash down sanitation, while maintaining full control.
- Maximize unit versatility with double acting lip control for end-loading applications.

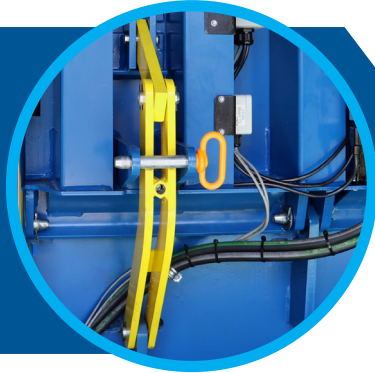

SAFETY

- High visibility yellow **run off guards** are built for safety and allow wider access to the trailer entry.
- Integral safety stand keeps the deck securely upright during servicing.
- Built-in maintenance strut with lockout pin prevents leveler use during cleaning or maintenance.
- Non-adjustable hydraulic velocity fuse limits loaded platform free-fall to within 3" (76 mm).
- High visibility beveled toe guards with OSHA striping improves worker safety.
- Constant pressure touch button allows the dock attendant to safely control the deck at all times.



DESIGN FEATURES

RELIABILITY

- Unique deck hinge design supports a smooth transition bridge between the dock and truck bed.
- **IntelliTilt™** feature uses a precision-based inclinometer to detect and communicate deck position.
- **SoftPark™** offers enhanced protective cushioning which safeguards the deck cylinder while the deck is being parked. Minimizing wear and tear to the facility floor.
- **SmartFloat™** State-of-the-art sensor technology allows the lip to maintain constant contact with the truck bed.
- Deck will flex up to 4" (102 mm) when under load, to ensure full-width contact between the lip and the truck bed.

QUALITY

- 8-10 enhanced J-beam channels are robotically welded to the underside of the deck at dynamic impact points to prevent distortion and extend the lifetime of the dock leveler.
- 5 rear deck-load support points ensure a distributed load with less wear and tear on the rear hinge, extending the product lifespan.
- Inverted deck cylinder is continually self-bleeding, reducing internal corrosion and increasing velocity fuse efficiency.
- 1HP (TENV) powerpack with separate manifold system for product longevity and serviceability.
- **PowderCoat™** is an effective rust proof solution which prolongs the life of dock equipment and helps maintain a sanitary environment.



ENGAGED SOLUTIONS

- The **Blue Genius™ Gold Series I Touch Control Panel** has flat-surface touch buttons and a keypad for easy management of all dock operations.
- LCD screen delivers operational, diagnostic, and troubleshooting messages in real-time.
- STOP button on control station halts the dock in mid-travel during an emergency condition.
- LED red / yellow / green control station lights send safety signals to dock personnel.
- The **Blue Genius™ Platinum Series** operates various combinations of loading dock equipment. A single control panel integrates all required functions, enabling the safe & simplified operation of any dock system from one central location.

VERTICAL STORING DOCK LEVELERS FOR COLD STORAGE FACILITIES

Maximum efficiency - Drive-Through application

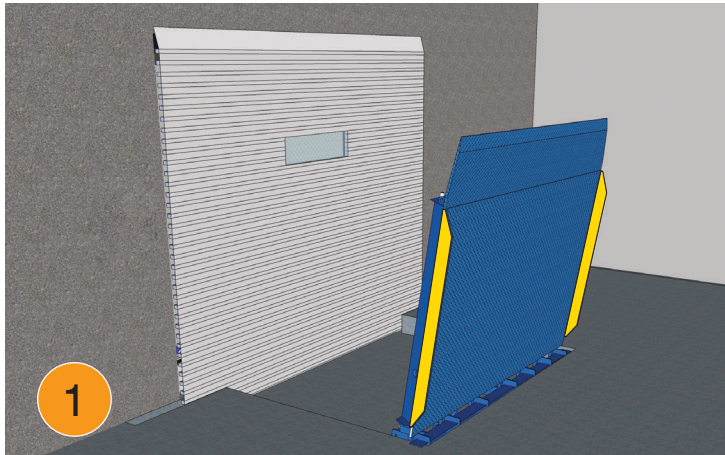

Vertically stored over-center, allowing the overhead door to remain closed, providing a tight seal.

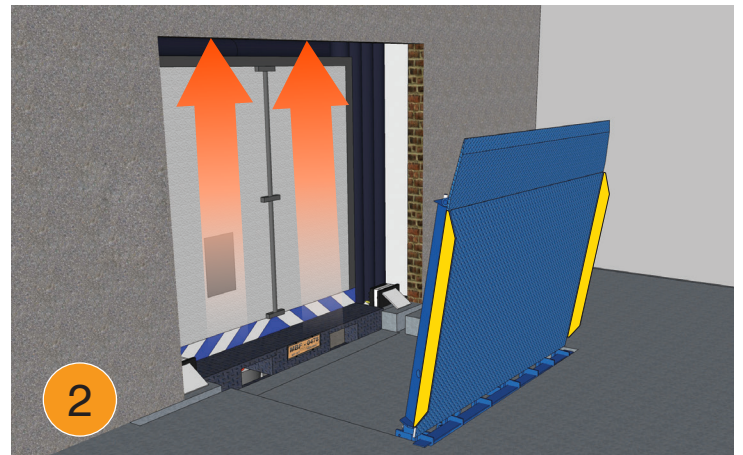

Trailer doors can remain closed and truck driver does not need to get out of the cab.

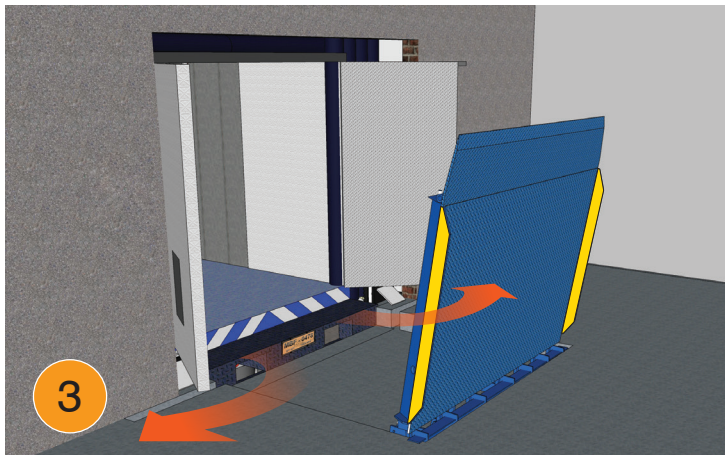

Dock attendant opens the trailer doors inside of the building and lowers the leveler into position.

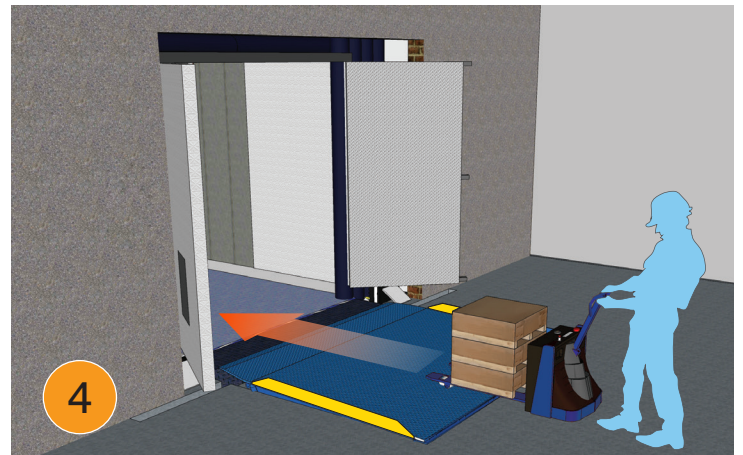

Loading and unloading process takes place like a standard pit-mounted leveler.

COLD STORAGE

- Maintain cold chain integrity during the loading and unloading process.
- Avoid exposure to the outside atmosphere while preserving climate control inside the facility.
- Eliminate internal temperature fluctuations.
- Ensure product quality from the arrival of raw materials to the shipping of finished goods.

CONTAMINANTS and CLEANLINESS

- Overhead doors remain closed and tightly sealed maintaining environmental control.
- Leave pests and debris outside.
- Easily wash down and sanitize the pit floor to ensure the highest level of cleanliness.
- Powder coat finish will not rust or corrode, keeping facility cleaner, longer.

APPLICATION BENEFITS

LEVELER SELECTION - LOAD CLASSIFICATION

TOTAL LOAD

LOAD WEIGHT + VEHICLE WEIGHT

≤ 5MPH

≤ 7% DECK GRADE

DAILY USAGE

FULL TRUCK (FTL) / CYCLES

FULL TRUCK (FTL)	CYCLES
0-8	0-200
9-16	201-400
17-24	401-600
≥ 24	≥ 600

FULL TRUCK = 24-26 PALLETS

LOAD CLASS

LOAD + USAGE

HEAVY

SUPER

EXTREME

LOAD USAGE
■ UP TO 33,000 LB
 For additional capacities, please contact Blue Giant

PIT DIMENSIONS

NOMINAL SIZE		FRAME WIDTH W		PIT LENGTH L	
		in	mm	in	mm
6' x 6'	1829 x 1829mm	81	2057	57.5	1461
				81.5	2070
6' x 8'	1829 x 2438mm	87	2210	57.5	1461
				81.5	2070
7' x 6'	2108 x 1829mm	92	2337	57.5	1461
				81.5	2070
Lip Length:		18", 20" (457, 508mm)			
Standard Pit Depth:		Front H : 12.5" (318mm)	Rear H : 12" (305mm)		
Optional Pit Depth:		Front H : 15.5" (394mm)	Rear H : 15" (381mm)		

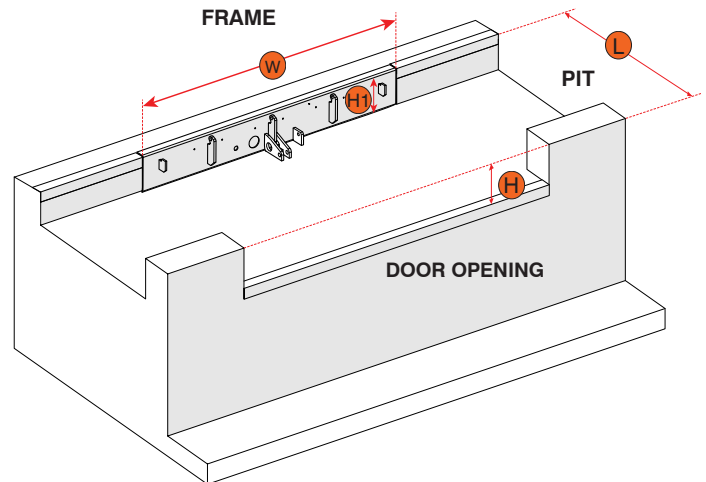

OPTIONS

- Up to 20" lip, longer options available please consult Blue Giant
- Extreme Arctic oil
- Advanced lights communication package
- Draft Pad

FINISH OPTIONS

- Anti-slip powder coat
- Enriched zinc powder coat
- Hot dipped galvanizing

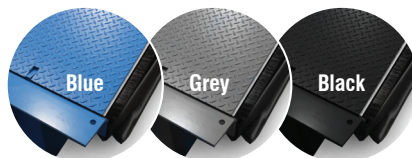

POWDERCOAT

Complete powder coat system prolongs the life of your dock equipment. This process is proven to be an effective rustproof solution which creates a safer work environment.

AUTHORIZED DEALER

Corporate 410 Admiral Blvd
Mississauga, ON, Canada L5T 2N6
905.457.3900 f 905.457.2313

USA 6350 Burnt Poplar Road
Greensboro, NC 27409
www.bluegiant.com

Blue Giant offers a full line of dock levelers, dock safety equipment, seals and shelters, accessories, ergonomic and scissor lift equipment and industrial trucks. Concurrent with our continuing product improvement program, specifications are subject to change without notice. Please contact Blue Giant for latest information. Some features illustrated may be optional in certain market areas.

If calling within North America: t 1.800.872.2583 f 1.888.378.5781

DL-VSDL-081024 © Copyright Blue Giant Equipment Corporation 2024